



Power is knowledge.™

LifeSafety Power®



FLEXPOWER®

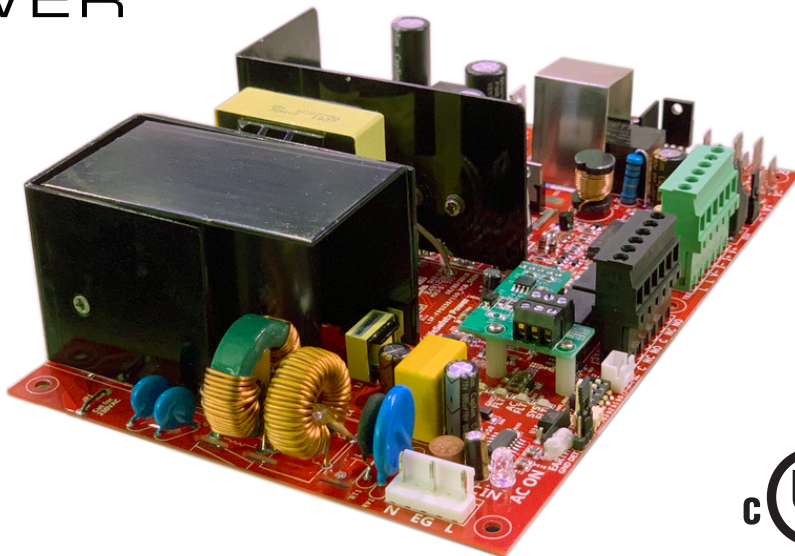

LifeSafety Power | PH 888.577.2898 | TechSupport@LifeSafetyPower.com



Table of Contents

Notes and Warnings	iii
Symbol Definitions	iii
Warnings	iii
Regulatory Information	iii
Conventions Used Within this Manual	iii
Power Supply Quick Start	iv
Section 1 – Installation and Operation	1
1.1 Mounting	1
1.2 Jumper / LED / Connector Descriptions	2
1.3 FAI Input Usage	6
1.4 Typical Installation & Wire Routing	7
1.5 AC Switch and terminal wiring	8
1.6 RS485 Address Switch Settings	8
1.7 Power-Up and Basic System Verification Checklist	9
Section 2 – Troubleshooting and Maintenance	10
2.1 Troubleshooting Table	10
2.2 Maintenance Instructions	11
Section 3 – Specifications	12
3.1 Electrical Specifications	12
3.2 Temperature Specifications	13
3.3 Mechanical Specifications	13
3.4 Replacement Parts	14
Appendix 1 – Tamper Switch Wiring	15
Appendix 2 – User Certificate	15
Appendix 3 – UL Compliance Verification Sheet	16











Notes and Warnings

Symbol Definitions

The following symbols are used throughout this manual:

-  This symbol is intended to alert the installer of shock hazards within the enclosure. Service should only be performed by qualified service personnel
-  This symbol is intended to alert the installer of important information intended to help the installer avoid personal injury or property damage

Warnings

-  All references to FPO, FPO75, FPO150, or FPO250 in this manual refer to the Generation 2 FPO family.
-  Installation and service should be performed only by qualified service personnel and should conform to all local codes
-  To reduce the risk of electric shock or fire, do not expose this equipment to rain or moisture
-  This equipment shall be installed in a manner which prevents unintentional operation by employees, cleaning personnel, or others working in the premises, by falling objects, customers, building vibration, or similar causes
-  This equipment is not intended for use within the patient care areas of a Health Care Facility
-  Replace fuses only with the same type and rating as indicated in the specifications section of this manual.
-  To prevent impaired operation, ensure that all wiring is routed and secured to prevent accidental open or short circuit conditions
-  The system and any batteries (if used) should be tested at least once per year to ensure proper operation
-  Batteries (if used) should be maintained at an ambient temperature of between 32 and 120 degrees Fahrenheit (0-49 Celsius) or premature loss of battery power could occur
-  For UL294 compliance, the battery set must be sized to provide a minimum of 4 hours standby at full load
-  Non-ProWire enclosure models must not integrate the SY-CLOUDLINK-G2 if compliance with ULC-S319 or ULC 60839-11-1 is required

Regulatory Information

The equipment discussed within this manual has been tested to the following standards:

- UL294, UL2610
- ULC S318, ULC S319
- CSA C22.2 #107.1, CSA C22.2 #205
- IEC 62368-1:2014, EN55032:2015
- EN61000-3-2:2014, EN6100-3-3:2013
- EN55024:2010 +A1:2015
- CE, UKCA, BIS IS13252(Part1):2010
- NOM 001:2018, RCM, SAA
- CSFM Approved, ROHS 3 Lead Free

FCC Information

Note: This equipment has been tested and found to comply with the limits for a Class A digital device, pursuant to Part 15 of the FCC Rules. These limits are designed to provide reasonable protection against harmful interference when the equipment is operated in a commercial environment. This equipment generates, uses, and can radiate radio frequency energy and, if not installed and used in accordance with the instruction manual, may cause harmful interference to radio communications. Operation of this equipment in a residential area is likely to cause harmful interference in which case the user will be required to correct the interference at his own expense.

Conventions Used Within this Manual

Positional information (e.g. top, bottom, up, down, left, right, etc.) is referenced with the board or enclosure in the orientation shown in the illustrations in this manual.

Power Supply Quick Start

This section gives a quick visual guide of installation connections and settings for installers already familiar with the FlexPower line of power supplies. For full information, please read this entire manual before installing.

QUICK INSTALL - SECTION FINDER

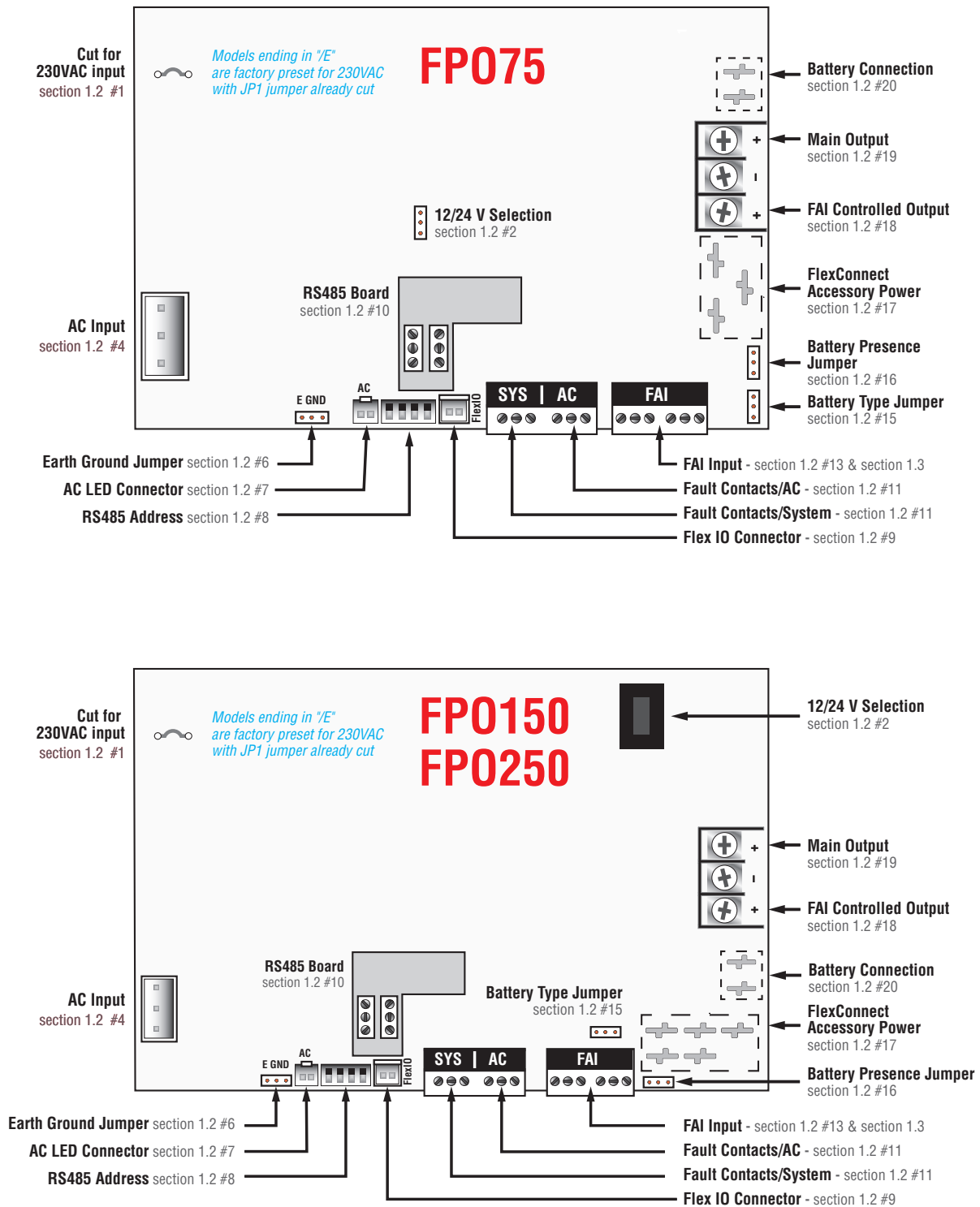

Figure 2



Section 1 – Installation and Operation

The following pages cover the installation, setup, and basic operation of the FPO series power supplies.

1.1 Mounting

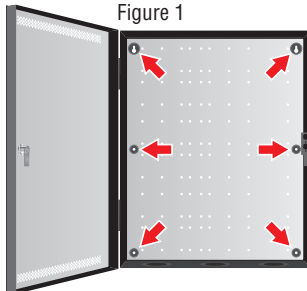

Figure 1

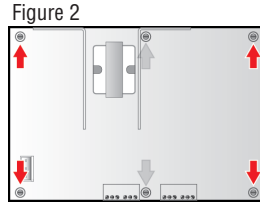

Figure 2

Figure 3



Mounting an Enclosure

Use the following procedure when mounting a wall-mount enclosure (figure 1).

1. (Optional) Remove the enclosure's cover.
2. Locate the top keyhole mounting holes in the back of the enclosure.
3. Mark and pre-drill the locations for the keyholes in the mounting surface.
4. Partially install two fasteners appropriate for the surface on which the enclosure is being installed. Leave the heads of the fasteners approximately 1/4" out from the surface. Minimum fastener size should be #10 or larger.
5. Hang the enclosure on the two fasteners and mark the locations of the remaining mounting holes.
6. Remove the enclosure and pre-drill the locations for the remaining mounting holes.
7. Re-hang the enclosure on the top mounting fasteners, start the remaining fasteners and tighten all fasteners.
8. Reinstall the enclosure's cover, if removed in step 1.
 - ⚠ It is the installer's responsibility to determine the appropriate fastening system for use with the surface the enclosure is being mounted to.
 - ⚠ For UL2610 applications, after installation is complete, the installer must install the two supplied 1" long screws to the edge of the enclosure's cover for additional security.

Mounting a Sub Assembly to an Enclosure

Third Party sub assemblies will be mounted in one of three methods based on the supplied mounting hardware (figure 5).

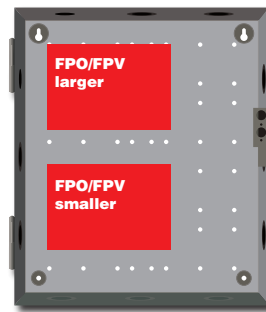

Figure 4

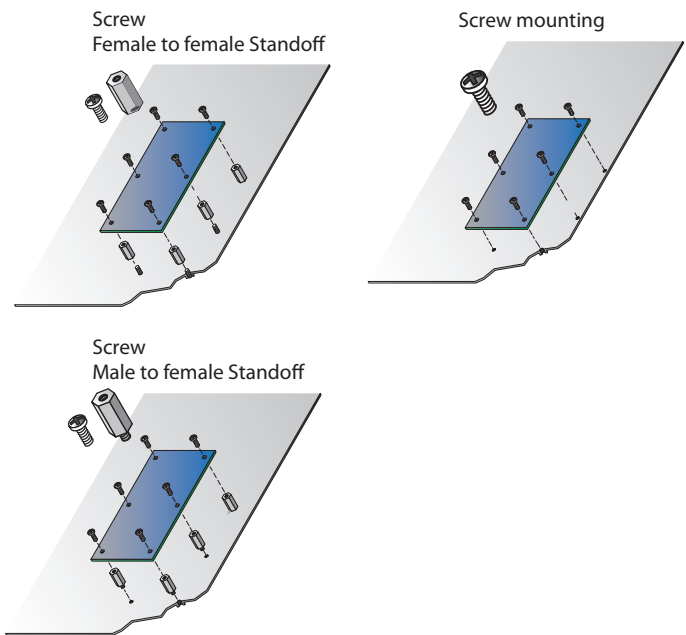

Figure 5

Mounting an FPO PS Board to an Enclosure

Use the following procedure when mounting an FPO power supply to a LifeSafety Power enclosure (figure 2).

1. Locate the appropriate mounting holes in the enclosure and snap the four or six standoffs provided into the holes.
2. Align the board mounting holes (mounting hole locations are indicated in the drawing above) with the standoffs and snap the board onto the standoffs. Be sure the board is properly oriented before snapping the board onto the standoffs (Figure 3).
3. When two FPO/FPV boards are installed, the larger shall be located on top (figure 4).

FP075

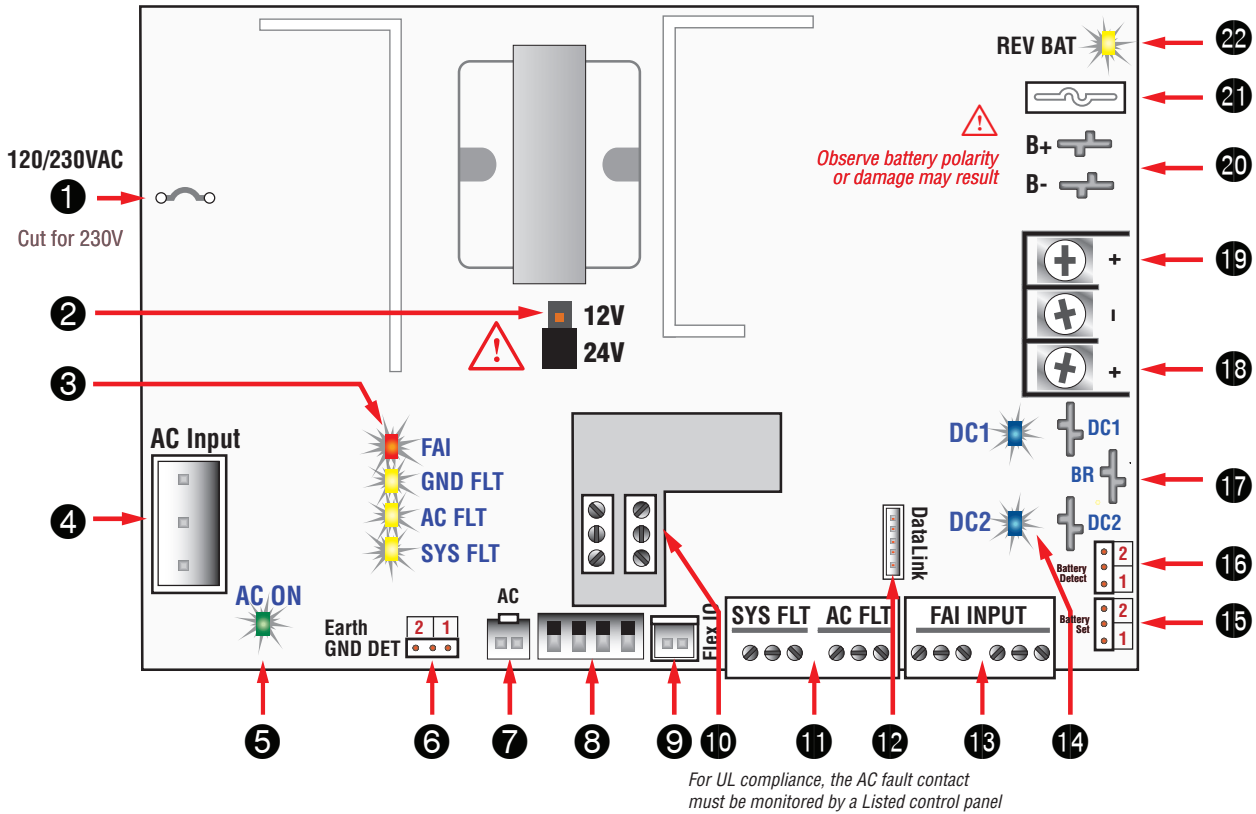

FP0150 / 250

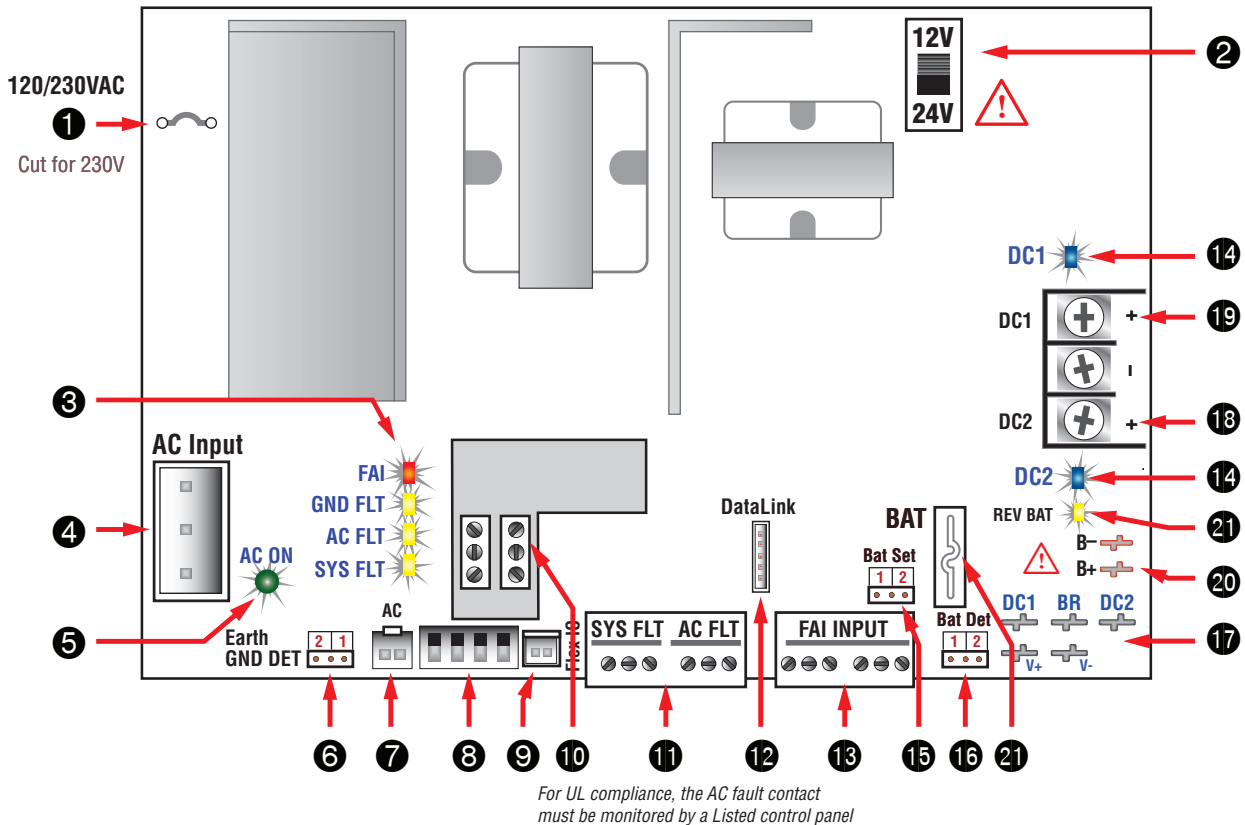



1.2 Jumper / LED / Connector Descriptions

1 AC Input Voltage Selection (JP1)

This jumper configures the FPO for the AC input voltage to be used.

- Leave jumper INTACT for 120V input
- CUT and remove jumper for 230V input

⚠ Models ending in "E" are preset for 230VAC

⚠ Failure to cut this jumper when using the FPO with a 230VAC input will result in damage to the system and void the warranty.

2 Output Voltage Selection (SW1)

This switch or jumper (depending on model) selects the output voltage of the FPO power supply. Voltage settings are labeled on the PC board as follows:

- **12** 12VDC nominal out
- **24** 24VDC nominal out

⚠ Remove power before changing output voltage or damage to the power supply could occur.

3 FAI and Fault LED Status Indicators

FAI (D22) – Red

This LED lights when a valid FAI signal is received on the FAI input terminals.

GND FLT (D42) – Yellow

This LED lights when an impedance is detected between earth ground and any voltage output or DC common. A Ground Fault will also light the System Fault LED.

AC FLT (D43) – Yellow

This LED lights when the AC input voltage is low or missing.

SYS FLT (D33) – Yellow

This LED lights when a system trouble is detected by the FPO. Trouble conditions indicated by the SYS FLT LED include:

- Missing Battery (If BAT DET jumper is ON)
- Earth Ground Fault (If EARTH GND DET jumper is ON)
- Battery voltage out of range
- DC output voltage out of range
- Ruptured fuse
- Accessory Board Fault
- Internal Fault

4 AC Input (J9)

J9 accepts the provided three-wire connector harness for connection to the AC Line. Cut jumper JP1 if powering the FPO with a 230VAC input. Connections are by wire nut as follows:

120VAC

White – Neutral
Green – Earth Ground
Black – Hot

230VAC

White – Phase 2
Green – Earth Ground
Black – Phase 1

⚠ Models ending in "E" have the JP1 jumper pre-cut for 230VAC operation only (see #1 above).

5 AC ON (D34) – Green

This LED lights when any AC voltage is present on the AC input. It does not indicate that the voltage is sufficient for proper operation of the FPO power supply. See the yellow AC FLT LED for AC voltage out of range indication.

⚠ Always confirm the absence of AC power with a meter before servicing to prevent electric shock.

6 Earth Ground Fault Detection (JP2)

The EARTH GND DET jumper enables or disables Earth Ground (EG) fault detection as follows:

- **Position 1** Enable EG Fault Detection
- **Position 2** Disable EG Fault Detection

Note: Position 2 is the factory default position

Earth Ground fault detection detects continuity between earth ground and any voltage output or DC common on the system.

⚠ Only one component of an entire system should be enabled for earth ground detection to avoid conflicts.

7 External AC LED Connection

This connector allows connection of an external AC ON indicator in rack mount applications. Only a LifeSafety Power AC LED should be connected.

8 RS485 Address Selection Switches

These switches select the RS-485 address for the FPO when using the RS485 connection. These switches are used only when the optional RS485 board is present (See #10). See section 1.6 for more information on these switches.

9 FlexIO Connection

This connector supplies the fault and FAI status between the FPO power supply and any accessory boards in the system. The appropriate cable is supplied with the accessory boards. For more information, see the instruction manual for any accessory boards used in the system.

10 RS485 Board (Optional)

This board provides the RS485 terminals for connection to an NLX network board. See the NLX manual for connection information.

11 Fault Output Connections (TB3)

These terminals provide the System Fault and AC Fault contact outputs. The terminals are removable and are labeled on the PC board in the non-powered (fault) state. For UL2610 compliance, a tamper switch must be wired in series with the Sys Fault contact output. See Appendix 1 for tamper switch wiring information. These terminals accept AWG14 – AWG22 wire. Fault conditions reported include:

AC FLT

- Low AC
- Missing AC
- Internal Fault

For UL compliance, the AC fault contact must be monitored by a Listed control panel

SYS FLT

- Missing Battery (If BAT DET jumper is ON)
- Earth Ground Fault (If EARTH GND DET jumper is ON)
- Battery voltage out of range
- DC output voltage out of range
- Ruptured fuse (DC1)
- Accessory Board Fault
- Internal Fault

FP075

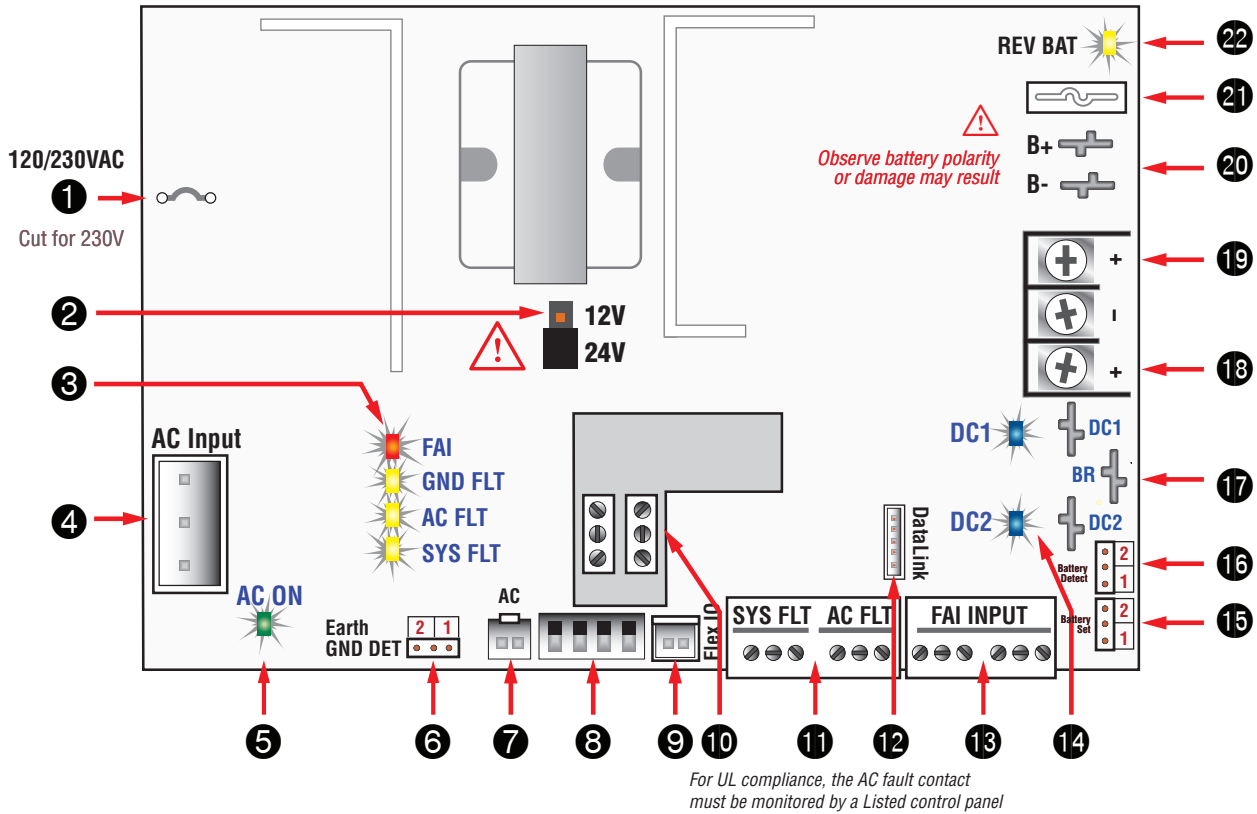

FP0150 / 250

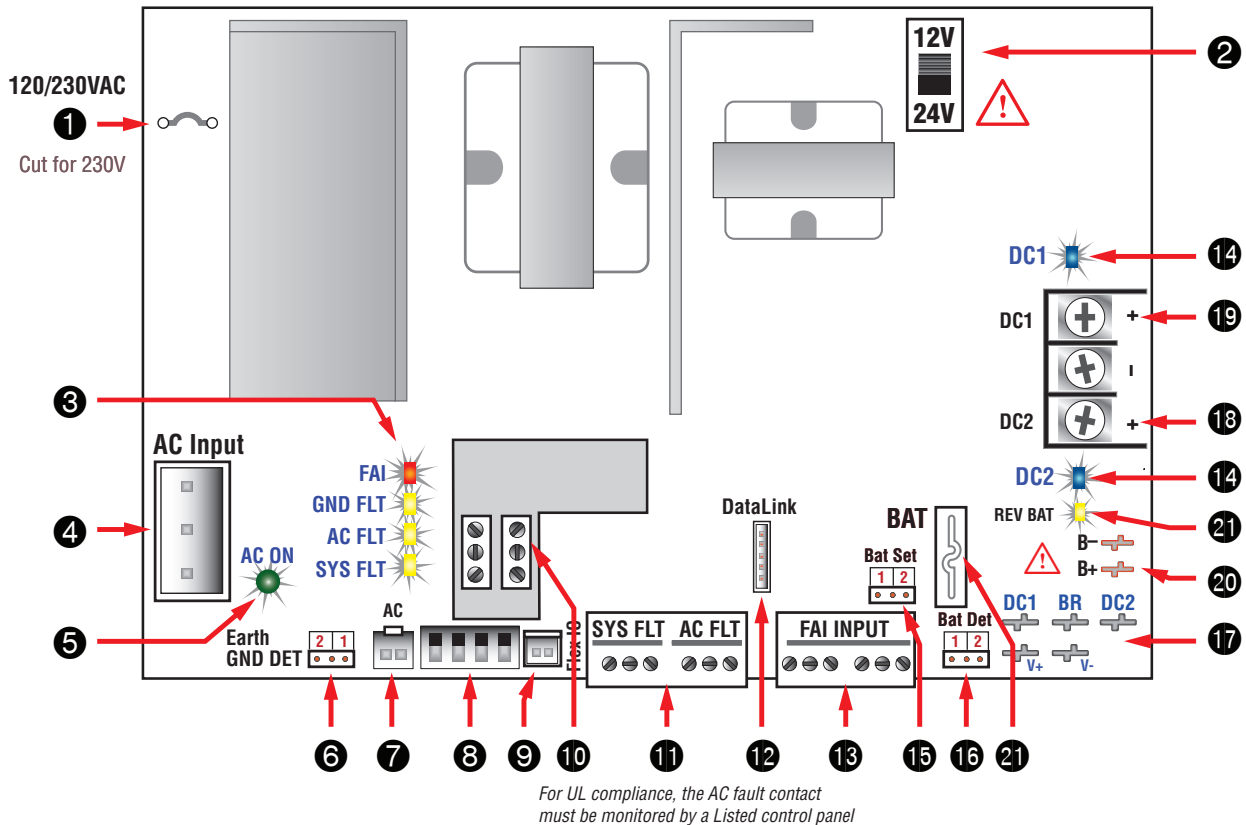



12 DataLink (SPI) Connection

This is the connector for the DataLink connection. It allows optional programming and monitoring of the FPO power supply via an optional NetLink network module.

See the instructions for the Netlink module for more information.

13 FAI Input Connections (TB2)

These terminals accept the optional FAI / Access Control input for controlling the DC2 output and any FAI capable accessory boards connected to the FPO power supply. The terminals are removable and are labeled on the PC board. These terminals accept AWG14 – AWG22 wire. See Section 1.3. Connections are as follows:

- **I+ & I– Terminals** These terminals are the input terminals for the FAI Input. The FAI input is activated when a voltage between 9 and 30 volts is applied across these terminals in the correct polarity. **See Section 1.3 - FAI Input Usage for more information.**
- **V+ & V– Terminals** These terminals are a low-current auxiliary voltage output and are typically used with a dry contact or open collector for activating the FAI Input's I+ and I- terminals.
- **L Terminals** Latch Reset contact input. If a latching FAI Input is desired, a normally closed contact is placed across these terminals. When the FAI Input is activated, it will latch in the activated state until this contact is momentarily opened. **If the latching feature is not desired, leave these terminals open.**

14 DC1 & DC2 – Blue/Green

These LEDs light when voltage is available on the DC1 and DC2 output terminals. The DC2 LED will extinguish if the output is disabled via the FAI input. This LED is dual color and indicates the output voltage as follows:

- **Blue** The output is set to 24V
- **Green** The output is set to 12V

15 Battery Type Selection

This jumper selects the type of battery being used. Select SLA for Sealed Lead Acid/Gel type batteries. Select LFP for Lithium Iron Phosphate batteries.

16 Battery Presence Detection (JP3)

The BAT DET jumper enables or disables Battery Presence fault detection as follows:

- **Position 1 (jumper ON)** Enable Battery Detection
- **Position 2 (jumper OFF)** Disable Battery Detection

⚠ Enabled (Position 1) is the factory default position which will cause a fault to occur if a battery is not connected.

Battery Presence fault detection indicates a fault when the backup battery is disconnected from the FPO power supply. If no backup battery is being used, this jumper should be placed in position 2.

17 FlexConnect Power Connections

Faston connectors for the power connection to any accessory boards to be connected. Pre-terminated power leads are provided with the accessory boards. For more information, see the instruction manual for any accessory boards used in the system. Connections are as follows:

- **DC1** This faston provides a constant voltage output for connection to the accessory boards.
- **BR** The DC Common (DC Ground) for the FPO power supply.

- **DC2** This faston provides an FAI controlled output that operates in conjunction with the DC2 output terminals. This connection is typically only used in single voltage systems with D8 accessory boards. See the sections on the FAI Input and DC2 Output Configuration for more information.
- **V+/V- (FPO150/250 only)** Faston connectors for powering a NetLink network module. Do not power the NetLink module from the DC1 or DC2 buss. See the NetLink module manual for more information.

18 DC2 Output (TB1)

The DC2 output may optionally be controlled by the FAI input. The full current of the FPO is available on this terminal. If not using the FAI input, the DC2 output may be used to provide continuous power. See the section on the FAI Input for more information. This terminal accepts AWG12 – AWG18 wire.

⚠ When powering magnetic loads such as maglocks, door strikes, solenoids, etc, each of these loads must have a reverse protection diode either built-in or external to the device.

19 DC1 Output (TB1)

The main DC output of the FPO power supply. The full current of the FPO is available on this terminal at all times and is unaffected by the FAI input. This terminal accepts AWG12 – AWG18 wire.

⚠ When powering magnetic loads such as maglocks, door strikes, solenoids, etc, each of these loads must have a reverse protection diode either built-in or external to the device.

20 Battery Connection (BAT+ & BAT–)

Faston connectors for connection of the backup battery set. Pre-terminated battery leads are provided. See the Specifications section for the maximum battery size. If no battery set is to be used, ensure the BAT DET jumper is off to prevent a fault condition from being annunciated. The generation 2 FPO power supply has built-in low battery disconnect to prevent deep discharge of the batteries and to prevent damage to sensitive equipment.

⚠ Select the proper battery type before connecting a battery set to the FPO power supply. See #15

⚠ Note that FPO75 PCB and FPO150-250 PCB's have different battery connection layouts.

⚠ An FPO set for a 12V output requires a 12V battery set. An FPO supply set for a 24V output must use a 24V battery set (two 12V batteries in series).

⚠ Observe polarity or damage to the system will occur.

⚠ It is the installer's responsibility to determine the proper battery size for the installation. See the Specifications section for standby current requirements.

21 Battery Fuse

This fuse is in series with the battery connection. Replace with only the same type and rating.

22 REV BAT (D20) – Yellow

This LED lights if the backup battery set is connected in the reverse polarity. The lighting of this LED will also be accompanied by the rupture of the battery fuse (F4) and the lighting of the SYS FLT LED.

1.3 FAI Input Usage

This section provides more detailed information on the connection and usage of the FAI input.

Activation with a Normally Open Relay Contact

FAI Activates when the NO contact CLOSES.
FAI Deactivates when the NO contact OPENS.

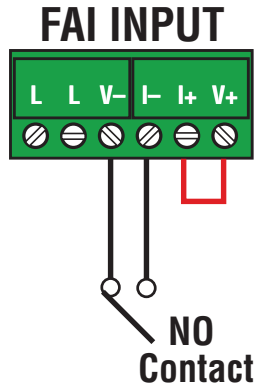

Latching the FAI Input

Latching of the FAI Input is achieved by placing a NC contact across the two 'L' terminals. The FAI may be activated by any of the methods listed. FAI Deactivates when the input is deactivated AND the NC Latching contact is momentarily OPENED.

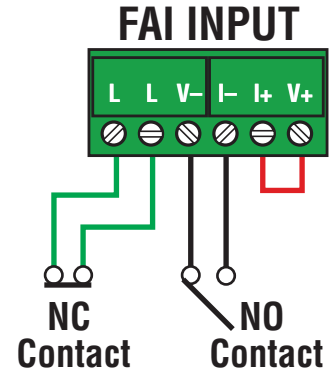

Example – NO Contact activation with latching

FAI Activates when the NO contact CLOSES. FAI Deactivates when the NO contact OPENS AND the NC contact momentarily OPENS.

Activation with a Normally Closed Relay Contact

FAI Activates when the NC contact OPENS.
FAI Deactivates when the NC contact CLOSES.

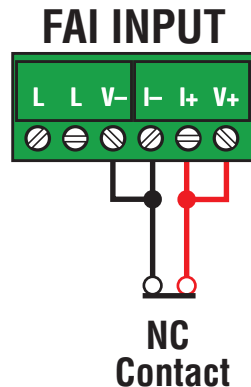

Note: FAI with a NC contact cannot be tested by removing the terminal strip, as this will remove the jumper wires from V+ and V- as well. To test, remove one wire going to the NC Contact.

FAI Activation with a Normally Open Relay Contact and FPO AC Fault Lock Override

FAI Activates either when the Fire Alarm NO contact CLOSES, or when the AC Fault NC contact CLOSES

FAI Deactivates either when the Fire Alarm NO contact OPENS, or when the FPO AC Fault NC contact OPENS

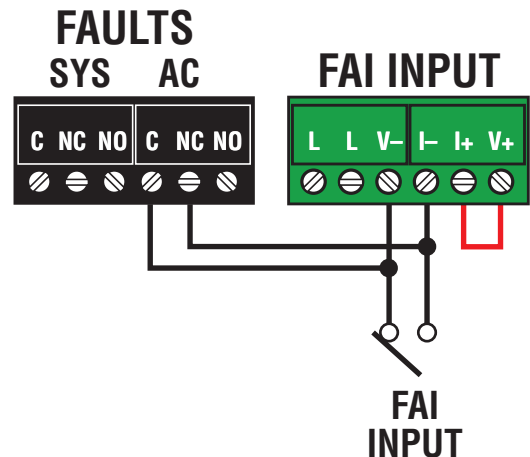

Activation with a Voltage Input

FAI Activates when voltage is APPLIED in the correct polarity. FAI Deactivates when voltage is REMOVED or the polarity of the voltage is REVERSED. Polarity shown in the ACTIVATED state

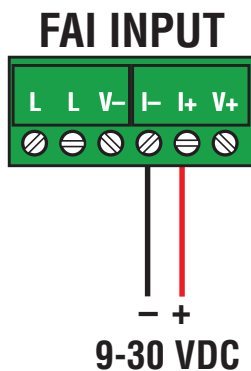



1.4 Typical Installation & Wire Routing

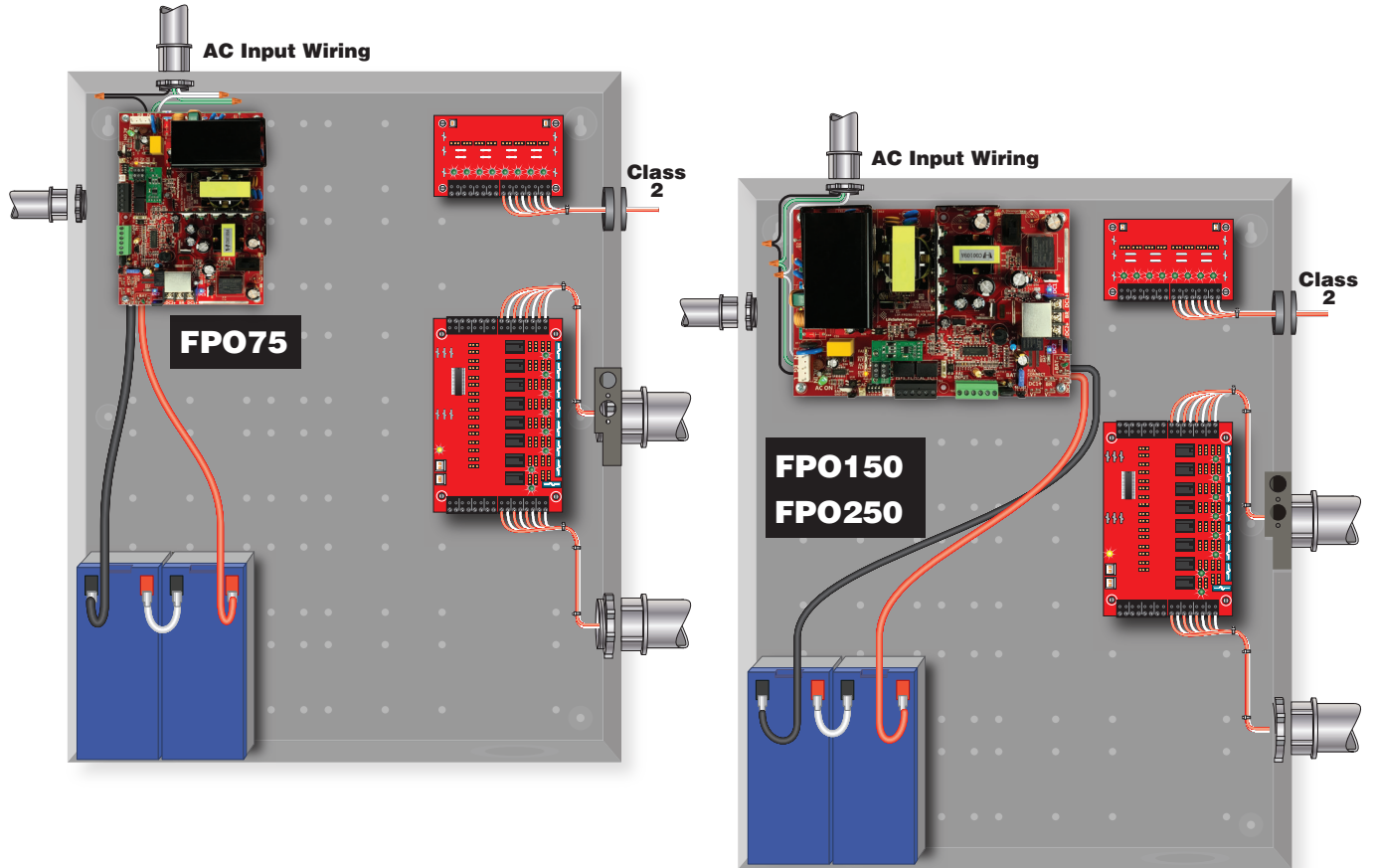

The drawing above shows a typical installation.

Actual configuration and wire routing will vary based on the components installed in your system.

The following guidelines should be followed for installation:

- Class 2 Power limited wiring must be separated from non-power limited wiring by a minimum of 1/4 inch and must use separate knockouts.
- The installation and all wiring methods shall be in accordance with ANSI/NFPA70 and all local codes.
- The installation and all wiring methods shall be in accordance with ANSI/NFPA70 and all local codes. For ULC S527 compliance, installation and all wiring methods shall be in accordance with the Canadian Electrical Code, C22.1, Part I, Section 32.
- Any wiring passing through knockouts in the bottom or top surfaces of the enclosure must be enclosed in rigid or flexible metal conduit.
- For **Canadian Installations** - For permanently connected equipment, a readily accessible disconnect device shall be incorporated external to the equipment. Output circuits not connected to removable terminal strips shall also utilize a readily accessible disconnect device.

1.5 AC Terminal and Switch Wiring

Some LSP enclosures contain a lighted AC disconnect switch and a terminal strip for the primary AC connection. The diagram below shows the connections for the switch and AC Input terminal strip.

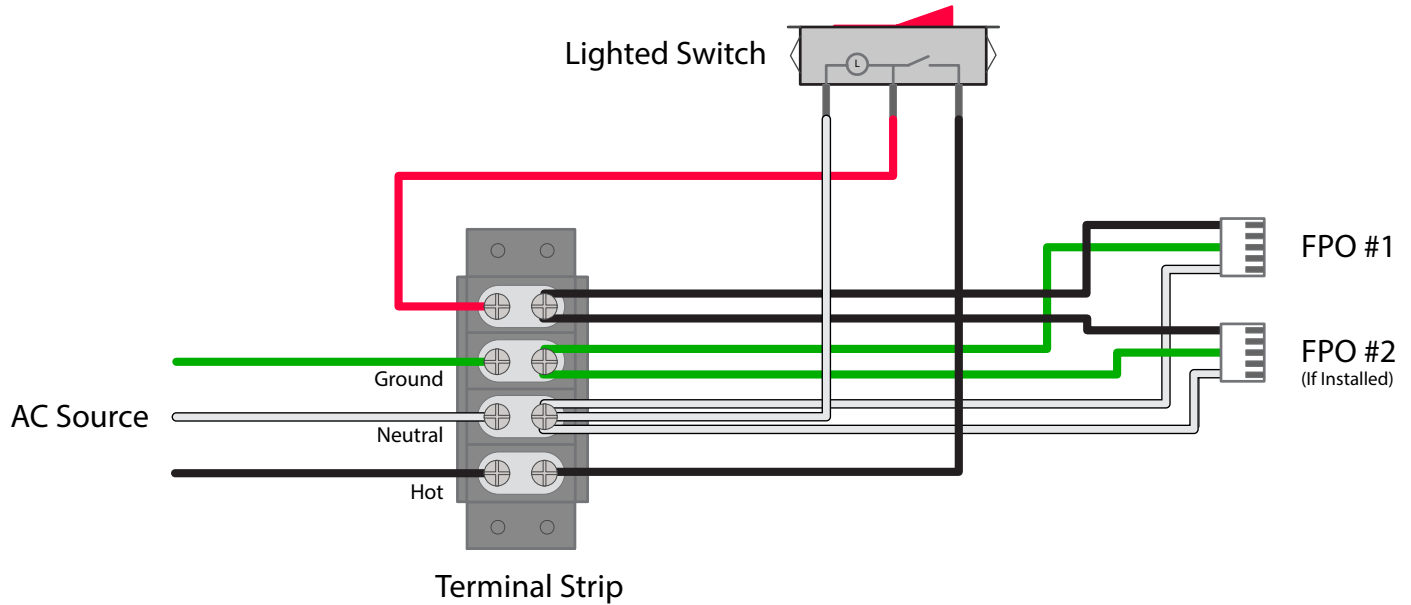

1.6 RS485 Address Switch Settings

These switches set the RS485 address when using the optional RS485 module on the FPO power supply. The switches set the address as shown in the table below. See the NLX manual for more information.

Address	Switch Settings	Address	Switch Settings
0	On On On On	8	Off On On On
1	On On On Off	9	Off On On Off
2	On On Off On	10	Off On Off On
3	On On Off Off	11	Off On Off Off
4	On Off On On	12	Off Off On On
5	On Off On Off	13	Off Off On Off
6	On Off Off On	14	Off Off Off On
7	On Off Off Off	15	Off Off Off Off



1.7 Power-Up and Basic System Verification Checklist

1. Ensure proper configuration of all jumpers and switches.
2. Apply AC power to the FPO power supply.
3. Ensure the “AC ON”, “DC1”, and “DC2” LEDs are lit.
4. Verify DC1 output voltage with a meter.
 - a. If set for the 12V nominal setting, the voltage should be approximately 12.5VDC
 - b. If set for the 24V nominal setting, the voltage should be approximately 25.0VDC
5. Connect battery, if required for the installation.
6. Verify that no yellow LEDs are lit on the FPO power supply.
7. If used, activate the FAI input and verify that the red “FAI” LED lights and that the DC2 output powers down. Deactivate the FAI input (and reset the input if configured for latching) and verify that the red FAI LED extinguishes and the DC2 output returns to normal.
8. If the battery presence jumper is enabled, remove one lead from the battery – verify that the yellow “SYS FLT” LED lights. Reconnect the battery and the “SYS FLT” LED should extinguish.
9. If the Earth Ground jumper is enabled, connect a wire from the ground stud on the enclosure to the DC1+ terminal – the “GND FLT” and “SYS FLT” LEDs should light. Remove the wire and the “GND FLT” and “SYS FLT” LEDs should extinguish. Repeat for the DC1- terminal.
10. When a standby battery set is used, remove AC power from the FPO power supply. Verify that the “DC1” LED remains lit and that the “AC FLT” LED lights. Reconnect AC power and verify that the “AC FLT” extinguishes.

Section 2 – Troubleshooting and Maintenance

2.1 Troubleshooting Table

Symptom	Possible Problem	Information / Possible Solution
SYS FLT LED lit and SYS FLT relay indicating a trouble condition	Battery Disconnected	<ul style="list-style-type: none"> Verify that the battery is connected to the FPO. Check all crimp connections on the battery leads Verify that the battery set being used is charged and in good condition If no battery will be used in the installation, remove the BAT DET jumper
	Earth Ground Fault	<ul style="list-style-type: none"> This fault will be accompanied by the GND FLT LED being lit and will only display if the EARTH GND DET jumper is ON An impedance exists between earth ground and a voltage output or DC Common connection on the FPO power supply, an accessory board, or any connected piece of equipment. Isolate the connection with the impedance by removing wires in groups or one at a time until the fault clears. Note that most accessory board terminal strips are removable Ensure that no other equipment in the system is set to detect earth ground faults (including other FPO power supplies in the system). Enabling earth ground detection on more than one piece of equipment in a system will cause a conflict and may cause one or all pieces of equipment in the system to display an earth ground fault
	Low Battery Voltage	<ul style="list-style-type: none"> Battery discharged or damaged– Allow the battery to charge or replace the battery
	High Battery Voltage	<ul style="list-style-type: none"> Incorrect battery set– Ensure the battery set is configured properly for the output voltage setting Problem with battery charging circuit– Contact LifeSafety Power
	High or Low Output Voltage	<ul style="list-style-type: none"> Measure the output voltage at the DC1 terminals. The voltage should be 12.50V for the 12V setting or 25.00V for the 24V setting ($\pm 10\%$). Contact LifeSafety Power if the voltage is outside of this range
	Blown Fuse	<ul style="list-style-type: none"> Check the Battery fuse. Verify the integrity of the output wiring and powered devices before replacing any ruptured fuses. Replace fuses only with the same type and rating
	Accessory Board Fault	<ul style="list-style-type: none"> Verify that no fault conditions are present on any accessory board or other FPO power supplies in the enclosure. The FlexIO connectors may be disconnected to isolate the source of an accessory fault.
AC FLT LED lit and AC FLT relay indicating a trouble condition	Internal Problem	<ul style="list-style-type: none"> Contact Lifesafety Power
	Primary AC Voltage Low or Missing	<ul style="list-style-type: none"> Verify that the AC input voltage is 120V or 230V ($\pm 15\%$) with a meter. For safety, the green AC ON LED indicates the presence of any AC voltage on the input, but not the integrity of the voltage
	120/230 Jumper (JP1) Set Incorrectly	<ul style="list-style-type: none"> Verify that JP1 is set correctly– intact for 120V input, cut for 230V input Note: Models ending in "-E" are factory set for 230VAC operation and cannot be changed to 110VAC operation
No DC1 Output DC1 LED Extinguished	Internal problem	<ul style="list-style-type: none"> Contact LifeSafety Power
	Power Supply Shut Down	<ul style="list-style-type: none"> Verify DC output voltage, AC power, and backup battery voltage (if used) Check output load integrity and current draw If the FPO detects ten output faults within one minute, the supply will shut down, transfer to battery backup (if available), and generate a fault condition. Cycle AC power to reset the supply after determining the cause of the output fault condition



Section 2 – Troubleshooting and Maintenance

2.1 Troubleshooting Table (continued)

Symptom	Possible Problem	Information / Possible Solution
No DC2 Output DC2 LSD Extinguished	Output disabled due to FAI	<ul style="list-style-type: none"> The DC2 output is disabled when the FAI input is active. Verify the red FAI LED is extinguished.
	Power Supply Shut Down	<ul style="list-style-type: none"> Verify DC output voltage, AC power, and backup battery voltage (if used) Check output load integrity and current draw If the FPO detects ten output faults within one minute, the supply will shut down, transfer to battery backup (if available), and generate a fault condition. Cycle AC power to reset the supply after determining the cause of the output fault condition
REV BAT LED lit	Battery connection reversed	<ul style="list-style-type: none"> Check the polarity of the battery connections at both ends of the battery harness This LED will be accompanied by a blown Battery Fuse
AC ON LED Extinguished	Missing or extremely low AC Input	<ul style="list-style-type: none"> Verify that the AC input voltage is 120V or 230V ($\pm 15\%$) with a meter
	Blown AC Fuse	<ul style="list-style-type: none"> The FPO power supply's AC input fuse is non-replaceable, as rupture of this fuse indicates a major malfunction within the FPO supply. Contact Life-Safety Power
Missing Battery Not Detected	Improper setting of BAT DETECT Jumper	<ul style="list-style-type: none"> The BAT DETECT jumper must be ON to detect a missing battery
Earth Ground Fault Not Detected	Improper Setting of EARTH GND DETECT jumper	<ul style="list-style-type: none"> The EARTH GND DETECT jumper must be ON to detect an earth ground fault
	Another device in the system has earth ground detection enabled	<ul style="list-style-type: none"> Only one device in the system can have earth ground fault detection enabled or conflicts will occur

2.2 Maintenance Instructions

The following are the maintenance instructions for the FPO Series power supply system

- Disconnect AC power prior to servicing
- Verify that there are no fault conditions displayed on any of the yellow fault LEDs as indicated in this instruction manual
- Verify the integrity of all fuses and replace as necessary using the fuse ratings supplied in the Specifications section of this manual
- The battery set (if used) should be checked and replaced if found to be defective or if more than 4 years old (or as required by local code)
- Verify that all output voltages are within range as specified in the Specifications section of this document

Section 3 – Specifications

3.1 Electrical Specifications

FPO Power Supplies

Specifications		FPO75	FPO150	FPO250
AC Input	Voltage	120VAC or 230VAC +10%/-15% at 50- 60Hz	120VAC or 230VAC +10%/-15% at 50- 60Hz	120VAC or 230VAC +10%/-15% at 50- 60Hz
	Current	1.6A	2.5A	3.2A
Standby	Current	100mA	100mA	100mA
DC Output at 12V Setting	Voltage	11.3 -12.0V	11.3 -12.0V	11.3 -12.0V
	Max Current	6A*	12A	20A* (18A* if charging battery)
* For UL2610 applications, FPO250 output current at 12V is derated to 12A max For UL2610 applications, FPO75 is derated to 4.5A at 12V output				
	Ripple	240mV	240mV	240mV
	Regulation	±2%	±2%	±2%
	Efficiency	80% (120VAC 60Hz In, Full Load, No Batt)	86% (120VAC 60Hz In, Full Load, No Batt)	88% (120VAC 60Hz In, Full Load, No Batt)
DC Output at 24V Setting	Voltage	23.5-24.0	23.5-24.0	23.5-24.0
	Max Current	3A	6A	10A**
** For UL2610 applications, FPO250 output current at 24V is derated to 8A max				
	Ripple	120mV	120mV	120mV
	Regulation	±2%	±2%	±2%
	Efficiency	80% (120VAC 60Hz In, Full Load, No Batt)	86% (120VAC 60Hz In, Full Load, No Batt)	88% (120VAC 60Hz In, Full Load, No Batt)
Battery	Type	Lead Acid, Gel Cell, or Lithium Iron Phosphate	Lead Acid, Gel Cell, or Lithium Iron Phosphate	Lead Acid, Gel Cell, or Lithium Iron Phosphate
	Charge Current	1A (±10%) Maximum (Adjustable via PowerCom Software)	2A (±10%) Maximum (Adjustable via PowerCom Software)	2A (±10%) Maximum (Adjustable via PowerCom Software)
Fuse Ratings	Battery	ATM 7.5A	ATM 15A	ATM 30A
BTU Output	BTU	33	66	109
Fault Setpoints	Low AC	95V (±6%)	95V (±6%)	95V (±6%)
	Earth GND	2000 Ohms	2000 Ohms	2000 Ohms
	Output Voltage	±10% of nominal	±10% of Nominal	±10% of Nominal
	Batt Voltage	±10% of nominal	±10% of Nominal	±10% of Nominal
	Batt Presence	6–15V (12V Setting), 11–29V (24V Setting)	6–15V (12V Setting), 11–29V (24V Setting)	6–15V (12V Setting), 11–29V (24V Setting)
Fault Relay Contacts	AC FLT	1A at 24VDC	1A at 24VDC	1A at 24VDC
	SYS FLT	1A at 24VDC	1A at 24VDC	1A at 24VDC



Section 3 – Specifications

3.2 Temperature Specifications

All Models

Ambient Temperature	0°C to 49°C (32°F to 120°F)
Ambient Humidity	93% at 32°C (90°F) maximum
Storage Temperature	-30°C to 70°C (-22°F to 158°F)

3.3 Mechanical Specifications

Visit www.lifesafetypower.com for AutoCAD files.

Power Supply Board - FP075

Size	6.00" L x 4.00" W x 2.00" H (152mm L x 102mm W x 51mm H)
Approximate Weight	0.75 lbs. (0.340 kg)

Power Supply Board - FP0150, FP0250

Size	8.25" L x 5.50" W x 2.5" H (210mm L x 140mm W x 64mm H)
Approximate Weight	1.38 lbs. (0a.626 kg)

Enclosure E1, E1x

Size	14" H x 12" W x 4.5" D (356mm H x 305mm W x 114mm D)
Approximate Weight (base cabinet)	8 lbs. (3.5 kg) empty

Enclosure E2, E2x

Size	20" H x 16" W x 4.5" D (508mm H x 406mm W x 114mm D)
Approximate Weight (base cabinet)	18 lbs. (8.0 kg) empty

Enclosure E5, E5x

Size	8.63" H x 11" W x 3" D (286mm H x 219mm W x 76mm D)
Approximate Weight (base cabinet)	4 lbs. (2.0 kg) empty

Enclosure E4, E4x

Size	24" H x 20" W x 6.5" D (508mm H x 508mm W x 165mm D)
Approximate Weight (base cabinet)	21 lbs. (9.5 kg) empty

Enclosure E6x

Size	30" H x 23" W x 6.5" D (762mm H x 584mm W x 165mm D)
Approximate Weight (base cabinet)	45 lbs. (21.0 kg) empty

Enclosure E8x

Size	36" H x 30" W x 6.5" D (910mm H x 760mm W x 165mm D)
Approximate Weight (base cabinet)	55 lbs. (25.0 kg) empty

Section 3 – Specifications

3.4 Replacement Parts

Board Kits	Description
FPO250	FPO250 replacement board
FPO150	FPO150 replacement board
FPO75	FPO75 replacement board
B100	DC-DC Converter (12VDC or adjustable 5 to 18VDC) replacement board
D8	Simple distribution replacement board
D8P	Simple distribution (Class 2) replacement board
F8	FAI controlled distribution replacement board
F8P	FAI controlled distribution (Class 2) replacement board
C4	Four zone power control replacement board
C4P	Four zone power control (Class 2) replacement board
C8	Eight zone power control replacement board
C8P	Eight zone power control (Class 2) replacement board
M8	Eight zone managed power control replacement board
M8P	Eight zone managed power control (Class 2) replacement board
NL4	NetLink network communication board (used in FPO systems)

Hardware	Description
AC Cable	AC Input Cable for FPO Power Supply
Battery Cable	Battery Harness – 24"
Module Cable - 12"	Accessory board cable set – 12"
Module Cable - 18"	Accessory board cable set – 18"
Fuse - 3A	ATM-3A Fuse – Bag of 25
Fuse - 5A	ATM-5A Fuse – Bag of 25
Fuse - 7.5A	ATM-7.5A Fuse – Bag of 25
Fuse - 10A	ATM-10A Fuse – Bag of 25
Fuse - 15A	ATM-15A Fuse – Bag of 25
Fuse - 30A	ATM-30A Fuse – Bag of 25
Standoffs	Nylon Standoffs – Bag of 25
Camlock Set	Key and Lock fits LSP "E" enclosure
Tamper Switch	Tamper Switch for LSP "E" enclosure



Appendix 1 – Tamper Switch Wiring

All FlexPower DC systems with an enclosure include a normally closed tamper switch for monitoring by the host panel. The tamper switch can either be brought into a dedicated input in the panel (see the panel's instructions), to the Event 1 input of a Netlink Network Module (See the Netlink's Instruction Manual), or the tamper switch may be series connected into the System Fault relay in the FPO supply as shown in the illustration.

Any UL2610 installation must use the tamper switch to indicate the opening or removal of the front door of the enclosure.

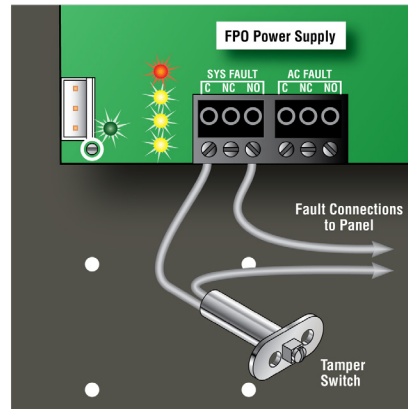

Appendix 2 – User Certificate

Below is a certificate required for UL2610 installations, to be cut out, framed and hung adjacent to the FlexPower Power Supply system after installation. It contains the required battery information, as specified in UL2610.



Specifications for the following model numbers:

FP0150 / FP0250

Maximum Charging Current:	2A
Maximum Battery Capacity:	80AH
Battery Type:	Sealed Lead Acid or Gel Cell

Specifications for the following model numbers:

FP075

Maximum Charging Current:	1A
Maximum Battery Capacity:	40AH
Battery Type:	Sealed Lead Acid or Gel Cell

Appendix 3 – UL Compliance Verification Sheet

General - All Applications:

1. The power supply must be installed within the protected area.
2. The LifeSafety Model EB-80 must be used to house the required battery(ies) when capacities of 40 to 80Ah are required. The EB-80 shall be mounted within 6ft of the power supply and the wiring enclosed in conduit.
3. Connections to the SYS FLT, AC FLT, and FAI inputs shall be completed within the same room, not exceeding a length of 3m.
4. Do not connect equipment to an AC power source that is controlled by a switch.
5. Trouble contacts shall be monitored by a listed alarm system.

The following sections cover specific requirements based on application:

UL2610, Proprietary Burglar Alarm Applications

1. The LifeSafety Model TS-20 tamper switch must be employed to monitor the power supply and EB-80 enclosures.
2. To achieve four hours of standby at full load current, 80Ah min. battery capacity is required for the FPO150 or FPO250. To achieve four hours of standby at full load current, 40Ah min. battery capacity is required for the FPO75.

S319, Access Control Applications

The LifeSafety Model TS-20 tamper switch must be employed to monitor the power supply and EB-80 enclosures.

For UL Compliance

Any locking device shall be configured for fail safe operation upon occurrence of an alarm as shown in Activation with a Normally Closed Relay Contact in Sec. 1.3, FAI Input Usage.



LifeSafety Power

10027 S 51st St, Suite 102
Phoenix, AZ 85044 USA

www.lifesafetypower.com

Phone (888) 577-2898

info1@lifesafetypower.com

IMPORTANT

All information, including illustrations, is believed to be reliable. Users, however, should independently evaluate the suitability of each product for their particular application. LifeSafety Power makes no warranties as to the accuracy or completeness of the information, and disclaims any liability regarding its use. LifeSafety Power's only obligations are those in the LifeSafety Power Standard Terms and Conditions of Sale for this product, and in no case will LifeSafety Power or its distributors be liable for any incidental, indirect, or consequential damages arising from the sale, resale, use, or misuse of the product. Specifications are subject to change without notice. In addition, LifeSafety Power reserves the right to make changes—without notification to Buyer—to processing or materials that do not affect compliance with any applicable specification.